



<b>Part no.</b>	<b>TOP5050RGB-E-S66</b>
<b>Emitting color</b>	<b>RED GREEN BLUE</b>
<b>Material</b>	<b>AlGaInP InGaN</b>
<b>Picture</b>	

■ **Absolute Maximum Ratings at (TA=25°C)**

Part No.	REVERSE VOLTAGE (<100 uA)	D.C.FORWARD CURRENT	PULSE CURRENT	OPERATING TEMPERATURE RANGE	STORAGE TEMPERATURE RANGE	LEAD SOLDERING TEMP.
TOP5050RGB-E-S66	5.0V	30mA	100 mA	-30°C TO +85°C	-40°C TO +100°C	260 FOR 4 SEC

■ **Electrical/Optical Characteristics at TA=25 °C**

Part No.		WAVELENGTH Hue @20mA (nm)		FORWARD VOLTAGE @20mA(V)		Reverse Current	LUMINOUS INTENSITY @20mA(mcd)	
		MIN	MAX	MIN	MAX	IR(VR=5V)	MIN	MAX
TOP5050RGB-E-S66	R	620	630	1.8	2.3	10uA	600	1200
	G	520	530	2.8	3.5	10uA	1000	1600
	B	465	475	2.8	3.5	10uA	200	600

IV :Tolerance each Binlimit is ±15%

VF: Tolerance each Binlimit is ±15%

■ **WAVELENGTH(IF=20mA.Ta=25 °C )**

COLOR	RED	GREEN	BLUE
ITEM	λ d 20mA(nm)		
BIN	MIN	MAX	
R	620	630	
G	520	530	
B	465	475	

■ **LUMINOUS INTENSITY@20mA(mcd)**

COLOR	RED	GREEN	BLUE
ITEM	IV 20Ma(mcd)		
BIN	MIN	MAX	
R	600	1200	
G	1000	1600	
B	200	600	

■ **FORWARD VOLTAGE@20mA(V)**

COLOR	RED	GREEN	BLUE
ITEM	VF 20mA(V)		
BIN	MIN	MAX	
R	1.8	2.3	
G	2.8	3.5	
B	2.8	3.5	

## Directivity

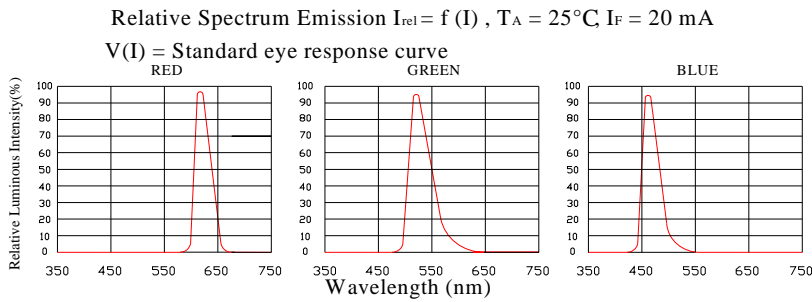

FIG.1 RELATIVE LUMINOUS INTENSITY

Forward Current  $I_F = f(V_F)$

$T_A = 25^\circ C$

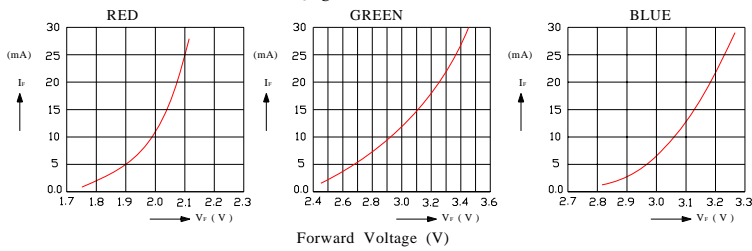

FIG.2 FORWARD CURRENT VS. FORWARD VOLTAGE

Relative Luminous Intensity  $I_v/I_v(20\text{mA}) = f(I_F)$

$T_A = 25^\circ C$

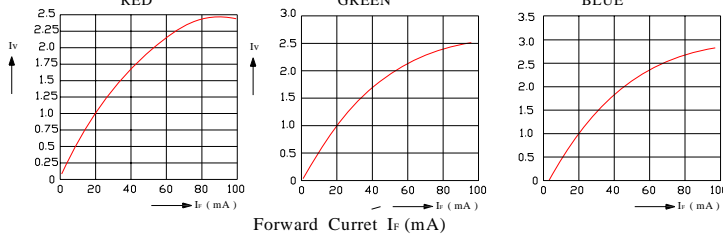

FIG.3 RELATIVE LUMINOUS INTENSITY VS. FORWARD CURRENT

Radiation Characteristic  $I_{rel} = f(\theta)$

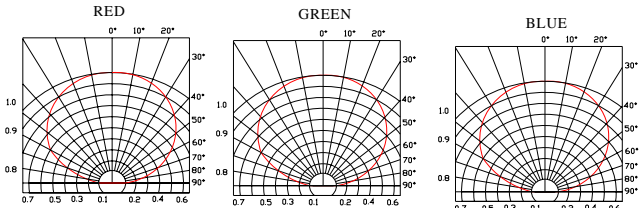
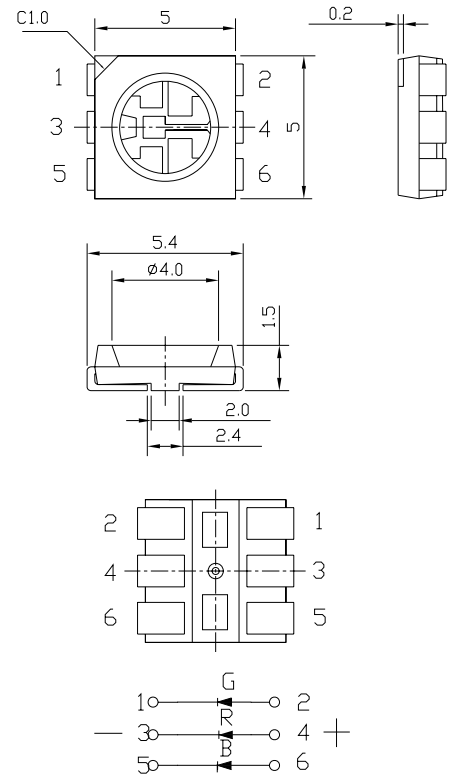
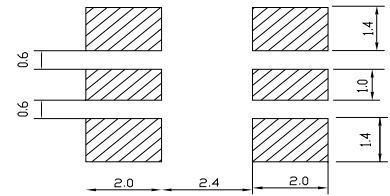

FIG.5 RADIATION DIAGRAM

## Dimensions(Unit:mm)



## recommended



## Package specifications(mm)

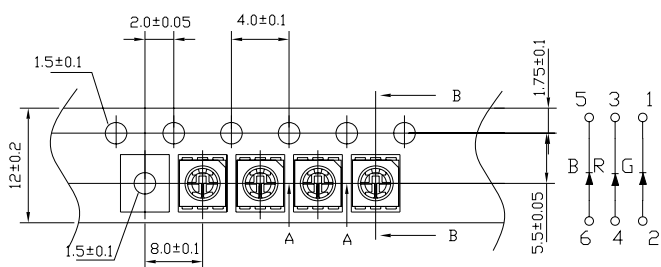

Reel & Packing specification.

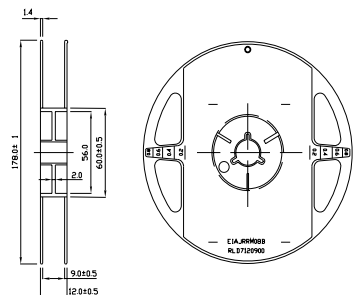
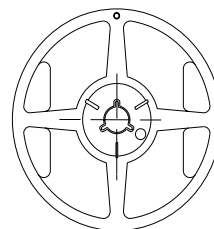



## RELIABILITY

TEST ITEMS AND RESULTS				
Test Item		Test Conditions	Note	Number of Damaged
Solderability (Reflow Soldering)	JEITA ED-4701 300-301	Tald=240±5℃ 3sec	1 time over 95%	0/50
Thermal Shock	MIL-STD 202-107D MIL-STD 705-1051 MIL-STD 808-1011	0℃ - 100℃ 15sec. 15sec	20cycles	0/50
Temperature Cycle	JEITA ED-4701 100-105	-40℃ - 25℃ - 100℃ - 25℃ 30min. 5min. 30min. 5min	100 cycles	0/50
Moisture Resistance Cyclic	JEITA ED-4701 200-203	25℃ - 65℃ - -10℃ 90%RH 24hrs/1cycle	10 cycles	0/50
Temperature Humidity Storage	MIL-STD202-103B JIS-C-7021 B-11	Ta=60℃ RH=90%	1000hrs	0/50
Low Temperature Storage	JIS-C-7021 B-12	Ta=-40℃	1000hrs	0/50
Steady State Operating Life of High Humidity Heat	MIL-STD202-103B JIS-C-7021 B-11	85℃, RH=85%, If=20mA	500hrs	0/50

### JUDGMENT CRITERIA OF FAILURE FOR THE RELIABILITY

Measuring items	Symbol	Measuring conditions	Judgement criteria for failure
Forward voltage	VF(V)	IF=20mA	Over U*1.2
Reverse current	IR(uA)	VR=5V	Over U*2
Luminous intensity	IV(mcd)	IF=20mA	Below S*0.5

Note: 1.U means the upper limit of specified characteristics. S means initial value.

2.Measurment shall be taken between 2 hours and after the test pieces have been returned to normal ambient conditions after completion of each test.

## LED 无铅锡过炉制程参考

Application(Soldering)

Manual soldering (We do not recommend this method strongly.)

Soldering tin material: tin 6/4 alloy or contained Ag.

To prevent cracking, please bake before manual soldering.

keep the temperature on the edge of iron at 300 ℃ Max. (25W)and apply for 3 seconds.If the temperature become higher,apply in a shorter time (1sec)

In manual soldering, take care not to damage the package especially terminal or resin.

(Do not give stress to the product when soldering.)

Do not use again it you remove the soldered product.

It is recommended using an iron with a temperature control.

Reflow Soldering

Recommend tin glue specifications:

Melting temperature:150-260℃

Contains:Sn 96.5% , Ag 3.0% ,Cu0.5 % JIS Z 3282TEST



YOHUA

# SUZHOU YOHUA OPTO-ELECTRONICS TECHNOLOGY LTD

Never take next process until the component is cooled down to room temperature after reflow.

The recommended reflow soldering profile (measuring on the surface of the LED resin) is following:

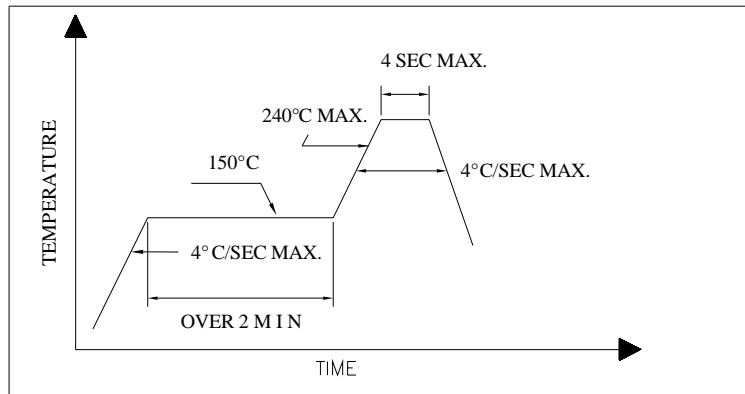

## Cleaning

The conditions of cleaning after soldering:

An alcohol-based solvent such as Isopropyl Alcohol (IPA) is recommended.

Temperature Time: <50°C\*30sec, or <30°C\*3min

Ultra sonic cleaning: <15W/bath; Bath volume: 1 liter max.

Curing: 100 max, <3min

## Cautions of Pick and Place

It should be avoided to load stress on the resin during high temperature.

Avoid rubbing or scraping the resin by any object.

Electric-static may cause damage to the component. Please confirm that the equipment is grounding well. Using an ionzer fan is recommended.

## Cautions of Design and Applications

It should be done to connect with a current-limiting serial resistor. Avoid to drive reverse voltage over the specifications on LED when ON/OFF.

Any application should refer to the specifications of absolute maximum ratings.

The dimensions of the recommended soldering pattern may not meet every user. Please confirm and study first before designing the soldering pattern in order to obtain the best performance of soldering.

Do not contact with any component on the assembly board.

## Label:

<b>SUZHOU YOHUA</b>	
<b>OPTO-ELECTRONICS TECHNOLOGY LTD</b>	
<b>Product No: TOP5050RGB-E-S66</b>	
<b>Quantity</b>	<b>:X PCS</b>
<b>WLD</b>	<b>:XXXX(nm)</b>
<b>VF</b>	<b>:XX- V</b>
<b>IV</b>	<b>:XX- mcd</b>
<b>LOT No. :XXXXXXXX</b>	
<b>TEL:0512-62697289 FAX:0512-62697290</b>	

- ← **YO HUA LOGO**
- ← **Part No**
- ← **Quantity**
- ← **CIE**
- ← **VF**
- ← **IV**
- ← **Lot No.**
- ← **YO HUATEL.FAX**



## Appendix

---

### Notes for designing

Care must be taken to provide the current limiting resistor in the circuit so as to drive the Yo Hua LEDs within the rated figures. Also, caution should be taken not to overload Yo Hua LEDs with instantaneous voltage at the turning ON and OFF of the circuit.

When using the pulse drive care must be taken to keep the average current within the rated figures. Also, the circuit should be designed so as to be subjected to reverse voltage when turning off the Yo Hua LEDs.

### Storage

In order to avoid the absorption of moisture, it is recommended to solder Yo Hua LEDs as soon as possible after unpacking the sealed envelope.

### **If the envelope is still packed, to store it in the environment as following**

- (1) Temperature: 5°C -30°C (41° F) Humidity: RH 60% Max.
- (2) After this bag is opened, devices that will be applied to infrared reflow, vapor-phase reflow, or equivalent soldering process must be:
  - a. Completed within 24 hours.
  - b. Stored at less than 30% RH.
- (3) Devices require baking before mounting, if:
  - (2) a or (2) b is not met.
- (4) If baking is required, devices must be baked under below conditions:  
48 hours at 70°C ± 3°C .

Thank you for your accessing to YOHUA product informations.

More detail product informations catalogs are available, please contact our office.

**SUZHOU YOHUA OPTO-ELECTRONICS TECHNOLOGY LTD.**

---

[WWW.YOHUA.COM.TW](http://WWW.YOHUA.COM.TW)

---

26L, No.369 Ta Yuan Road, Su Zhou New District, Jiang Su Province, China

TEL:0512-62697289

FAX:0512-62697290

---

2014.01.06